



PLYWOOD ASSOCIATION OF AUSTRALIA LTD

STRUCTURAL PLYWOOD WALL BRACING



LIMIT STATE DESIGN MANUAL

ACKNOWLEDGEMENT

This literature was developed with funding assistance from the Forest and Wood Products Research and Development Corporation.

FOREST & WOOD PRODUCTS
RESEARCH & DEVELOPMENT CORPORATION

PRODUCT CERTIFIED



JAS-ANZ



An accredited body under Reg. No Z1460695AB

STRUCTURAL PLYWOOD WALL BRACING

Wind and earthquakes have historically caused damage to low rise buildings in Australia. These potentially damaging phenomena result in all buildings requiring bracing, especially those with modern open plan designs with wide openings. Structural plywood provides a simple but reliable means to brace these building frames. This manual explains to designers and builders how to brace framing in accordance with the new limit state revision of AS1684 'Residential Timber-Framed Construction'. The change to limit state design allows a more reliable design than believed possible with permissible stress design. For permissible stress bracing design the design capacities are given in the appendix of this manual.

BENEFITS OF USING PAA STRUCTURAL PLYWOOD

Safety and Reliability

- Guaranteed by the PAA third party audited JAS-ANZ accredited Product Certification Scheme to fully comply with AS/NZS2269 'Plywood-Structural'
- Bonded with durable 'marine' A bond
- Proven performance based on extensive laboratory testing
- Written into AS1684 'Residential Timber-Framed Construction'

User Friendly

- Install using simple hand or gun fastener - can fasten within 7mm of edges
- Cross-laminated plywood construction resists site, impact, and edge damage

Design Feasibility & Cost Effectiveness

- High strength and stiffness in relatively short panels with simple fixings allowing wider windows and reduced numbers of walls
- Can provide safe and reliable bracing during the vulnerable construction period

INDEX

Why Plywood Bracing		3
Design Methodology	Design Approach Design Parameters Design Criteria	3
Material Specification	Plywood Framing Fasteners	4
Establish Design Racking Forces	Maximum Design Gust Wind Speed Wind Classification Area of Elevation Design Racking Force	5
Structural Plywood Bracing Systems	Standard Range - Flat Head Fasteners Internal Lining - Bullet Head Fasteners	10
Additional Installation Requirements	General Distribution and Spacing of Bracing Walls Fixing of Bottom of Bracing Walls Uplift Resistance of Bracing Walls Fixing of Top of Bracing Walls	14
Holes Through Plywood Bracing		18
Design Example		18
Appendix	Permissible Stress Design Capacities	19

WHY PLYWOOD BRACING

The Australian Standard 'Residential Timber-Framed Construction' states "Permanent bracing shall be provided to enable the roof, wall and floor framework to resist horizontal forces (racking forces) applied to the building. Appropriate connection shall also be provided to transfer these forces through the framework and sub-floor structure to the building's foundation."

The structural plywood bracing systems described in this manual provide a safe and reliable means of permanent bracing that is easy to install and very cost effective.

Diagram 1 provides an illustration of how wind forces act on a building.

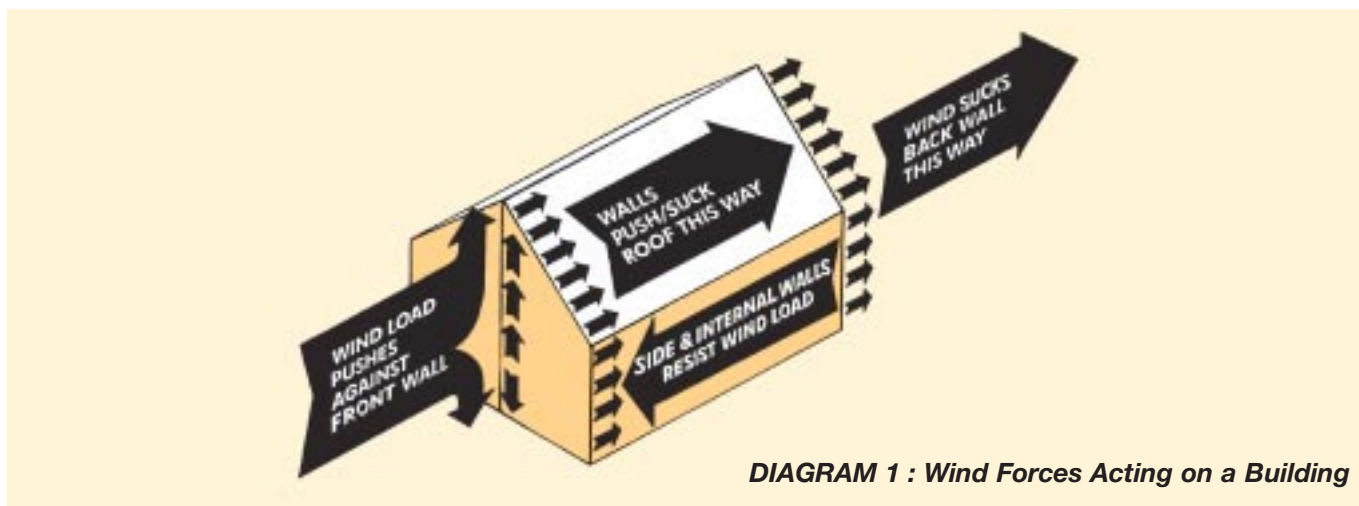

DIAGRAM 1 : Wind Forces Acting on a Building

The horizontal wind (racking) forces resulting from the wind flow on the top half of the external cladding are transferred into the ceiling (roof or top floor) diaphragm. These forces can be safely and reliably resisted by vertical structural plywood shear walls. The racking forces from the lower half of the external cladding and those from the plywood bracing are both transferred by the floor (diaphragm) and its supports down into the foundations.

If one applies this logic to double storey construction it can be demonstrated the wind forces applied to lower storeys can approach 3 times those on the top storey. This fact, coupled with the trend of having large rooms (with less walls) with wider openings and the use of non-structural linings makes the structural design of these modern buildings more critical.

DESIGN METHODOLOGY

Design Approach

1. Establish the wind forces on the walls of the building, perpendicular to the wind flow in the two primary building dimensions, viz. normal to the building length and width. These forces can be assessed using AS1170.2 'Wind Loading Code', AS4055 'Wind Loads for Housing' or AS1684 'Residential Timber-Framed Construction'. For convenience, Table 4 provides the wind pressure tables for Wind Classification N2 from AS1684.

Design Parameters

1. Buildings whose plan shape is essentially rectangular or a combination of rectangular elements.
2. Maximum building width of 15m.
3. Maximum roof pitch is 35°.

Design Criteria

The following design criteria were applied to the full scale prototype tests done in approved Australian laboratories to the requirements of AS1720.1-1997 'Timber Structures Code' to establish limit states for structural plywood sheathed panels.

1. The allowable deflection i.e., racking out of square, was limited to panel height/300 or 8mm at the serviceability limit state.
2. Where plywood buckling generated an alternative serviceability limit state the design load was taken within the Limit of Proportionality of the load/deflection plot i.e., design

2. Select the appropriate structural plywood bracing system or combination of systems.
3. Through multiplying the selected bracing resistances by the length of each bracing system parallel to the wind direction, ensure the total bracing resistance in these walls equals or exceeds the design wind forces in this direction. Do likewise for the other primary direction.

4. Up to 2.7m wall height. Over 2.7m linearly reduce the bracing resistance in the ratio of 2.7m divided by the actual height.

loads were taken prior to the onset of any buckling.

The strength limit state (irrespective of its cause) was determined by working backwards from the test panel ultimate load to establish an Equivalent Test Load (ETL). From this the design action effect for the bracing walls were determined.

3. The serviceability limit state loads incorporate a minimum factor of safety of 2.0 on the ultimate failure load of the prototype test panels.

MATERIALS SPECIFICATION

Permanent structural bracing enables wall systems to resist horizontal forces i.e. racking forces, applied to the building by wind and/or earthquake. Appropriate connections are required to transfer these forces through a structurally sound

system and subfloor to the ground. Thus for safety and reliability of structural bracing the following material specifications are critical.

Plywood

To comply with the requirements of this manual the plywood must be branded with the PAA/JAS-ANZ 'tested structural' Product Certification stamp. This stamp ensures the plywood has been manufactured to the requirements of AS/NZS2269 'Plywood-Structural' under the PAA/JAS-ANZ accredited third party audited, process based, quality assurance program, and that the plywood will be predictable and reliable making it fit for purpose in this engineered application.



Framing

The framing must be designed to carry the horizontal forces to and from the plywood. In the case of timber the framing must be in accordance with the requirements of AS1684, or framing manual produced in accordance with the design parameters of AS1684. The testing of bracing on structural timber was on

timber of a minimum joint strength of J4 or JD4. Additional testing has verified if the framing is of the lower joint strength JD5 then the design racking resistances must be reduced by 12½%, requiring a proportional increase in the required bracing wall length.

Fasteners

Connection of the structural plywood to the framing is critical in bracing. In general, the failure in testing was in the connections. Table 1 specifies the minimum hand or power

driven fasteners for timber framing. The spacings for staples are two thirds (i.e. fastener spacing multiplied by 0.66) those shown for nails or screws.

TABLE 1: Minimum Fastener Specification

Hand Driven Nails	Power Driven Nails	Power Driven Staples
2.80mm dia. x 30mm flathead structural clouts or connector nails	Senco TN22-38 APB (2.33mm dia. x 38mm flathead)	Senco N17 BAB
	Bostitch CR3D (3.06dia. x 32 flathead) Bostitch C45D-250 or AC45P-250-GW (2.5dia. x 45 flathead)	Bostitch BCS4-1232
	Jambro B20998 (RBC 2.80mm dia. x 32mm zinc plate barb)	Jambro A10617 (G5562-38mm)
	Duo-Fast C27/32GD	

- Notes:**
1. Fasteners with equivalent dimension i.e. head size and shape, shank diameter and length to those in Table 1 are deemed acceptable.
 2. All fasteners are to be galvanised or suitably coated.
 3. Minimum edge clearance for fasteners is 7mm.
 4. If smaller diameter hand driven nails are used, the spacings of nails can be reduced in the ratio of the basic lateral loads per nail for J4 or JD4 joint group given in Table 4.1 of AS1720.1 'Timber Structures Code' for the lower nail diameter relative to the tabulated load for a 2.8mm diameter nail.
 5. Fasteners are not to be overdriven.
 6. Fasteners for structural plywood linings as detailed in Tables 13 and 14 can be a minimum of 2.5mm dia. x 40mm bullet head nails.

When coach screws or bolts are used to fix plywood panels, bottom plates or as tie rods, steel washers must be used. Table 2 provides detail of the minimum allowable washer size.

Circular washers of equivalent thickness and nett bearing area are an acceptable alternative.

TABLE 2 : Minimum Steel Washers (mm)

M10 Bolt/Coach Screw	38 x 38 x 2.0
M12 Bolt/Coach Screw	50 x 50 x 3.0
M16 Bolt/Coach Screw	65 x 65 x 5.0

ESTABLISH DESIGN RACKING FORCES

The limit state design racking forces can be calculated using AS1170.2 'Wind Loading Code', or more simply, by using the AS1684 'Residential Timber-Framed Construction' method. The

prerequisite for use of this simpler method described below is the 'design gust wind speed' and/or 'wind classification', and the 'area of elevation'.

Maximum Design Gust Wind Speed

The wind speed can be established by a number of methods, viz:
 (i) The Local government Authority may have maps prepared showing wind speed or wind classification zones.
 (ii) The maximum design gust speed can be derived using AS1170.2.

(iii) The wind classification can be established by use of AS4055 'Wind Loads for Housing' (a rationalised interpretation of AS1170.2).

Wind Classification

The AS1684 wind classification system is a rationalised means of categorising the wind speeds into bands for the non-cyclonic Regions A and B, and the cyclonic Regions C and D. Table 3 shows the various wind classifications in terms of the maximum

design gust wind speed. Also included in the table is a multiplier to be applied to the pressures given in Table 4 for other than N2 wind classification.

TABLE 3: Wind Classification in Terms of Wind Speed

Wind Classification		Maximum Design Gust Wind Speed (m/s)			Multiplier for wind pressures in Table 4
Regions A and B	Regions C and D	Permissible stress design	Serviceability limit state	Ultimate limit state	
N1	-	28	26	34	0.72
N2	-	33	26	40	1.00
N3	C1	41	32	50	1.56
N4	C2	50	39	61	2.33
-	C3	60	47	74	3.42

Note: The regions are given in detail in AS1170.2 and AS4055. Regions B, C and D occur within 100km of the Australian coast north of the 30° latitude line (i.e. just north of Coffs Harbour). The balance of Australia being designated as Region A.



Preservative treated structural plywood serving the dual purposes of cladding and of bracing

Area of Elevation

The area of elevation, to which the pressures from Table 4 are applied to calculate the design racking force, is proportional to the wind force applied to the frame of the relevant storey of the building. The area referred to is the area of the full building elevation above half way up the wall frame for the particular storey of the building being assessed. This is illustrated in Diagram 2.

The wind direction used shall be that resulting in the greatest load. As wind can blow from any direction, e.g. a single storey dwelling having a gable at one end and hip the other, will result in a higher load at right angles to the width of the house when the gable end is facing the wind. For complex building shapes a combination of shapes may be considered individually and individual loads added together later.

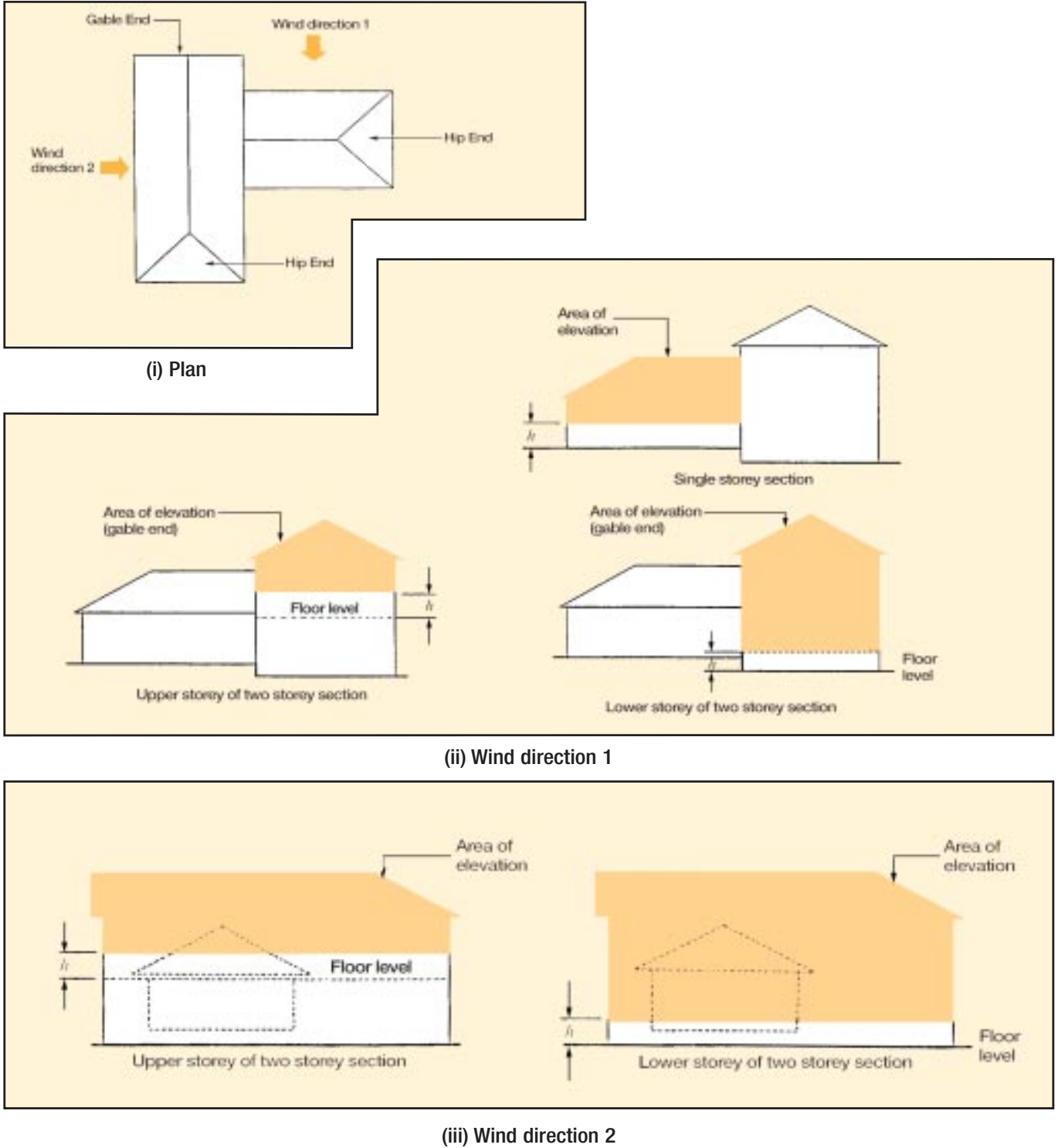

- Notes:**
- 1 h = half the height of the wall (half of the floor to ceiling height).
 - 2 For lower storey of two storey section h = half of the height of the lower storey (i.e. lower storey floor to lower storey ceiling).
 - 3 The area of elevation of eaves up to 1000mm wide may be ignored in the determination of area of elevation.

DIAGRAM 2: Determination of Area of Elevation

Design Racking Force

The design racking force for each storey or level of the building for each wind direction is the product of the Area of Elevation and the relevant wind pressure for the particular Wind Classification, i.e.

$$\text{Total Racking Force (kN)} = \text{Projected Area of Elevation (m}^2\text{)} \times \text{Lateral Wind Pressure (kPa)}.$$

The Lateral Wind Pressures for Wind Classification N2 are given in Table 4. For other Wind Classifications, the pressures from Table 4 are to be factored down or up using the multiplier given in Table 3 e.g. for N1 wind classification the pressures from Table 4 are to be multiplied by 0.72.

TABLE 4 : Wind Pressures (kPa) on Projected Area for Wind Classification N2

- (a) Single storey, upper of two storey, lower storey or sub-floor - all vertical surface elevations (gable ends, skillion ends and flat wall surfaces)

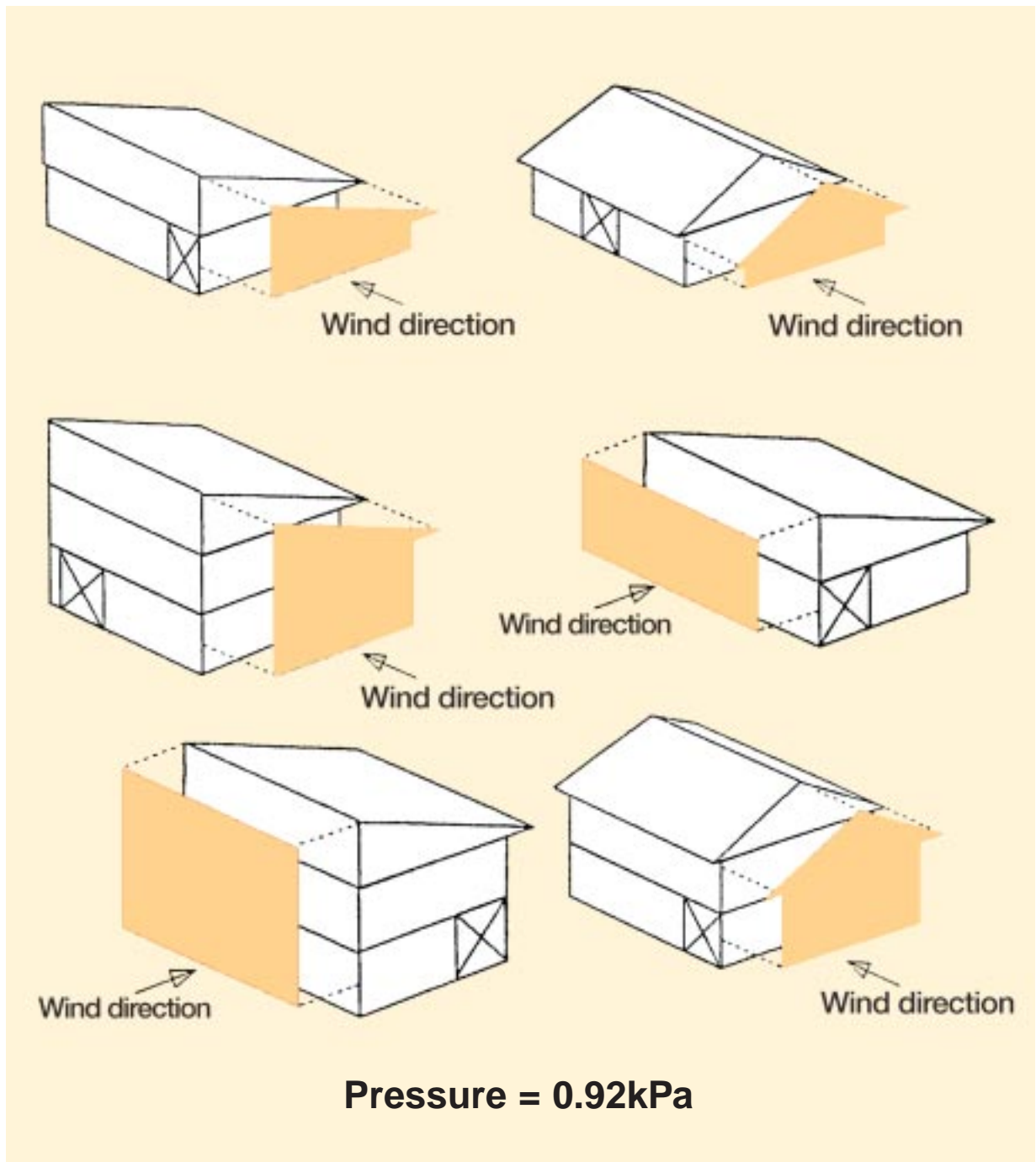
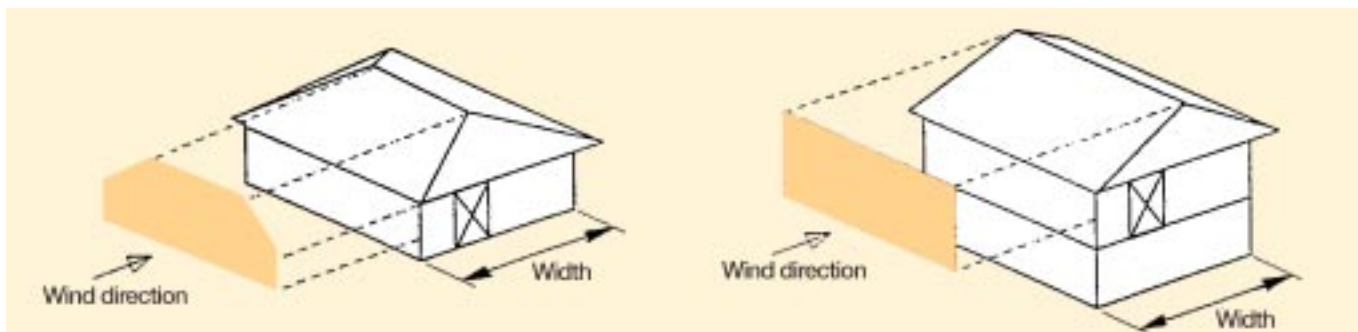

Table 4 (cont.)

(b) Single storey or upper of two storey - long length of building - hip or gable ends



Width (m)	Roof Pitch (degrees)							
	0	5	10	15	20	25	30	35
4.0	0.84	0.74	0.67	0.61	0.61	0.72	0.77	0.76
5.0	0.84	0.71	0.64	0.57	0.58	0.69	0.75	0.74
6.0	0.84	0.69	0.61	0.55	0.59	0.70	0.74	0.74
7.0	0.84	0.67	0.58	0.53	0.59	0.70	0.73	0.74
8.0	0.84	0.65	0.56	0.51	0.60	0.71	0.72	0.75
9.0	0.84	0.64	0.54	0.49	0.61	0.71	0.71	0.75
10.0	0.84	0.62	0.52	0.48	0.61	0.72	0.70	0.75
11.0	0.84	0.60	0.50	0.48	0.62	0.72	0.71	0.75
12.0	0.84	0.59	0.47	0.49	0.63	0.72	0.71	0.76
13.0	0.84	0.57	0.45	0.49	0.63	0.73	0.71	0.77
14.0	0.84	0.56	0.43	0.50	0.64	0.73	0.72	0.77
15.0	0.84	0.55	0.42	0.50	0.65	0.73	0.72	0.77
16.0	0.84	0.53	0.40	0.51	0.65	0.73	0.72	0.78

NOTE: 0° degree pitch is provided for interpolation purposes only.

(c) Lower storey or sub-floor - long length of building - hip or gable ends

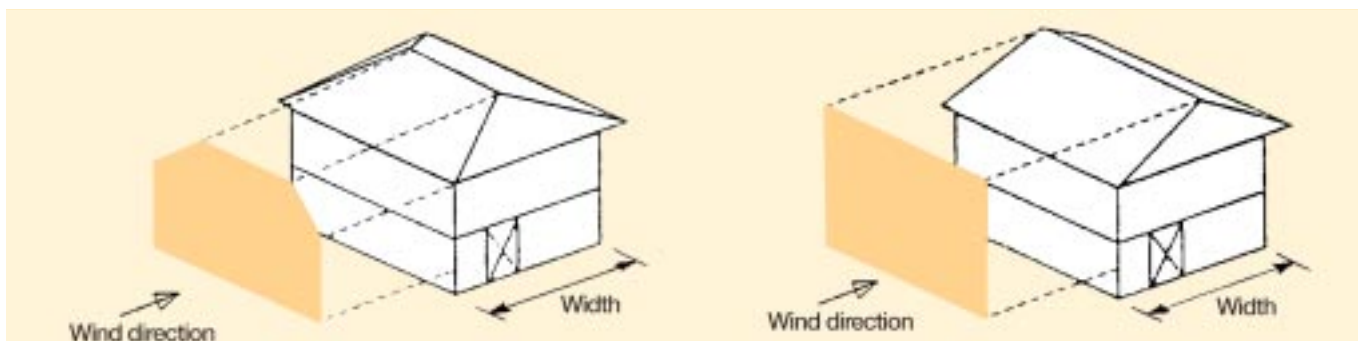

Width (m)	Roof Pitch (degrees)							
	0	5	10	15	20	25	30	35
4.0	0.84	0.81	0.78	0.75	0.75	0.83	0.85	0.84
5.0	0.84	0.80	0.77	0.73	0.73	0.82	0.84	0.83
6.0	0.84	0.79	0.75	0.72	0.73	0.81	0.83	0.82
7.0	0.84	0.78	0.74	0.70	0.72	0.81	0.82	0.82
8.0	0.84	0.78	0.73	0.69	0.72	0.81	0.81	0.82
9.0	0.84	0.77	0.71	0.68	0.72	0.81	0.80	0.81
10.0	0.84	0.76	0.70	0.67	0.72	0.81	0.79	0.81
11.0	0.84	0.75	0.69	0.66	0.72	0.80	0.79	0.81
12.0	0.84	0.74	0.68	0.66	0.72	0.80	0.79	0.81
13.0	0.84	0.74	0.66	0.66	0.72	0.80	0.79	0.82
14.0	0.84	0.73	0.65	0.66	0.73	0.80	0.79	0.82
15.0	0.84	0.72	0.64	0.66	0.73	0.80	0.79	0.82
16.0	0.84	0.72	0.63	0.66	0.73	0.80	0.79	0.82

NOTE: 0° degree pitch is provided for interpolation purposes only.

Table 4 (cont.)

(d) Single storey or upper of two storey - short end of building - hip ends

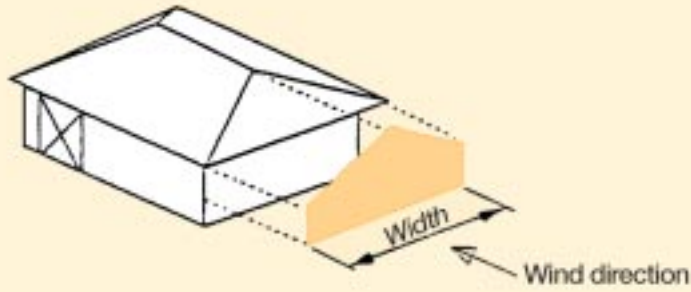

Width (m)	Roof Pitch (degrees)							
	0	5	10	15	20	25	30	35
4.0	0.92	0.86	0.81	0.77	0.76	0.79	0.82	0.81
5.0	0.92	0.84	0.79	0.74	0.73	0.77	0.81	0.79
6.0	0.92	0.83	0.77	0.72	0.73	0.77	0.79	0.79
7.0	0.92	0.82	0.75	0.70	0.73	0.77	0.78	0.79
8.0	0.92	0.80	0.73	0.68	0.72	0.77	0.77	0.79
9.0	0.92	0.79	0.71	0.66	0.72	0.77	0.76	0.79
10.0	0.92	0.78	0.69	0.65	0.72	0.77	0.75	0.78
11.0	0.92	0.77	0.68	0.64	0.72	0.77	0.75	0.79
12.0	0.92	0.76	0.66	0.64	0.72	0.77	0.75	0.79
13.0	0.92	0.75	0.64	0.64	0.73	0.77	0.75	0.79
14.0	0.92	0.73	0.62	0.64	0.73	0.77	0.76	0.79
15.0	0.92	0.72	0.60	0.64	0.73	0.77	0.76	0.80
16.0	0.92	0.71	0.59	0.64	0.73	0.77	0.76	0.80

NOTE: 0° degree pitch is provided for interpolation purposes only.

(e) Lower storey or sub-floor - short end of building - hip ends

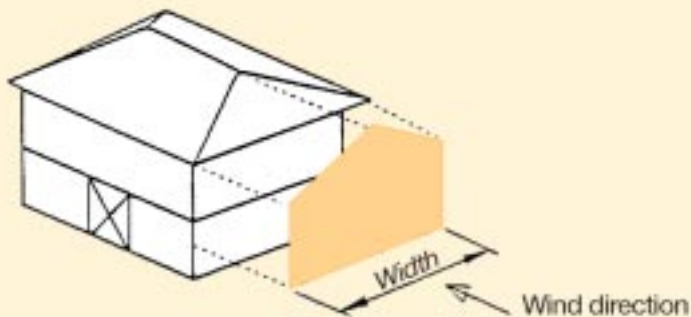

Width (m)	Roof Pitch (degrees)							
	0	5	10	15	20	25	30	35
4.0	0.92	0.90	0.89	0.87	0.86	0.87	0.88	0.87
5.0	0.92	0.90	0.88	0.85	0.85	0.86	0.87	0.87
6.0	0.92	0.89	0.87	0.84	0.85	0.86	0.87	0.86
7.0	0.92	0.89	0.86	0.84	0.84	0.86	0.86	0.86
8.0	0.92	0.88	0.85	0.83	0.84	0.85	0.85	0.86
9.0	0.92	0.88	0.84	0.82	0.84	0.85	0.84	0.85
10.0	0.92	0.87	0.84	0.81	0.83	0.85	0.84	0.85
11.0	0.92	0.87	0.83	0.80	0.83	0.85	0.84	0.85
12.0	0.92	0.86	0.82	0.80	0.83	0.85	0.83	0.85
13.0	0.92	0.86	0.81	0.80	0.83	0.84	0.83	0.85
14.0	0.92	0.85	0.80	0.80	0.83	0.84	0.83	0.85
15.0	0.92	0.85	0.79	0.79	0.83	0.84	0.83	0.85
16.0	0.92	0.85	0.78	0.79	0.83	0.84	0.83	0.85

NOTE: 0° degree pitch is provided for interpolation purposes only.

STRUCTURAL PLYWOOD BRACING SYSTEMS

After establishing the design racking forces for each storey or level and in both primary directions, a building frame can be braced by installing sufficient length of an appropriate system or a combination of the structural plywood bracing systems shown in Tables 5 to 14.

It is good practice to use bracing in all corners in external walls for each direction and level. Additionally, it is necessary to use an even distribution of bracing rather than to concentrate a large proportion of the bracing resistance in a comparatively short length of a high capacity bracing resistance system. The distribution and maximum spacings are detailed in the section Additional Installation Requirements.

The bracing resistances shown in Tables 5-14 apply to wall frames up to a height of 2.7m. For wall heights over 2.7m the bracing is reduced in the ratio of 2.7m divided by the higher wall height, e.g. with a 3m high frame, this reduction factor would be 0.9 .

For bracing system resistances greater than 6.4kN/m the

bottom and top plates must be a minimum of 70 x 70mm F5 or 90 x 45mm F5 or equivalent.

The bracing resistances given in Tables 5-14 are applicable to frames sheathed one side only. The resistances are additive for frames sheathed on two sides, however, the hold down requirements of the bottom plate must also be increased accordingly. Bottom plate sizes should be checked under these circumstances to ensure safe moment capacity.

If approved staples are used the spacings are to be a maximum of two thirds those for nails or screws shown in Tables 5 to 14.

The allowable design resistances are appropriate to all species, joint strength groups to J4 or JD4 and stress grades of wall framing timber. This covers most Australian hardwood and exotic pines. If species of JD5 joint strengths are used then additional testing has shown that the design values should be reduced 12.5%. Imported unidentified softwood may fall into this category.

TABLE 5: Minimum Structural Plywood Thicknesses for 3kN/m Bracing Capacity Systems (mm)

Plywood Stress Grade	Stud Spacing 600mm (max)
F8	7
F11	4.5
F14	4
F27	3

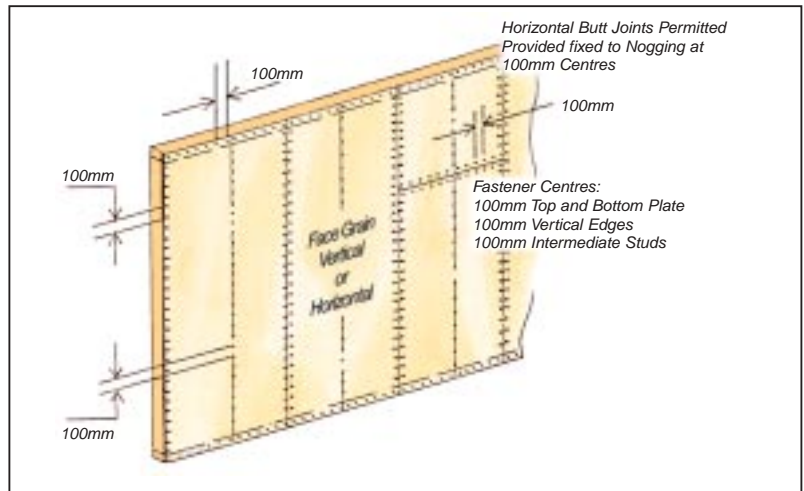

NOTE: These systems are only applicable to sheathed sections a minimum of 900mm wide.

TABLE 6: Minimum Structural Plywood Thicknesses for 3.4kN/m Bracing Capacity Systems (mm)

Plywood Stress Grade	Stud Spacing	
	450mm	600mm
F8	7	9
F11	4.5	7
F14	4	6
F27	3	4.5

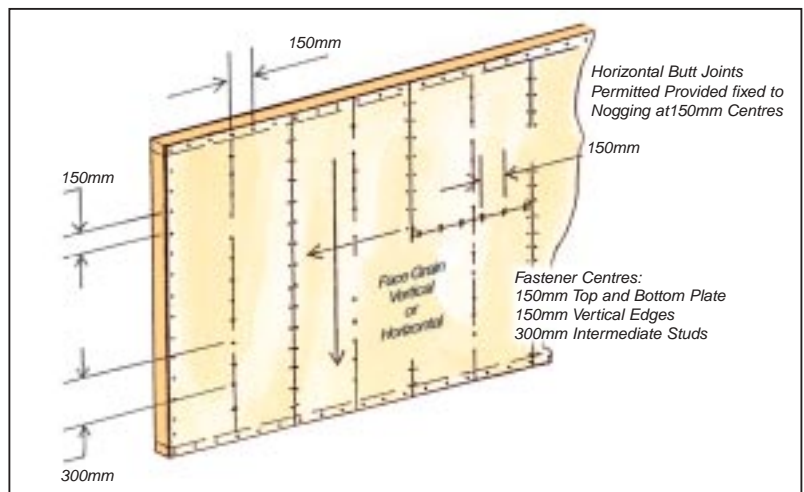

NOTE: For sheathed systems less than 900mm in width the appropriate reduction factor from Table 9 must be applied to the 3.4kN/m bracing capacity.

TABLE 7: Minimum Structural Plywood Thicknesses for Alternate 3.4kN/m Systems Utilising Nogging (mm)

Plywood Stress Grade	Stud Spacing 600mm (max)
F8	7
F11	4.5
F14	4
F27	3

NOTE: For sheathed systems less than 900mm in width the appropriate reduction factor from Table 9 must be applied to the 3.4kN/m bracing capacity.

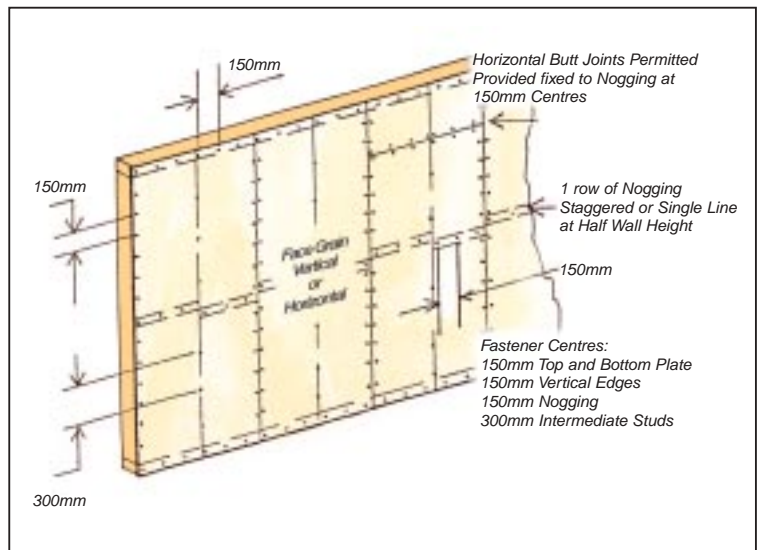

TABLE 8: Minimum Structural Plywood Thicknesses for 6.4kN/m Bracing Capacity Systems (mm)

Plywood Stress Grade	Stud Spacing	
	450mm	600mm
F8	7	9
F11	6	7
F14	4	6
F27	4	4.5

NOTE: For sheathed systems less than 900mm in width reduction factors from Table 9 must be applied. For 600mm or wider sections the fitting of M10 Coachscrews are not required to achieve the reduction factor of 1 as the two M12 tie rods make them superfluous.

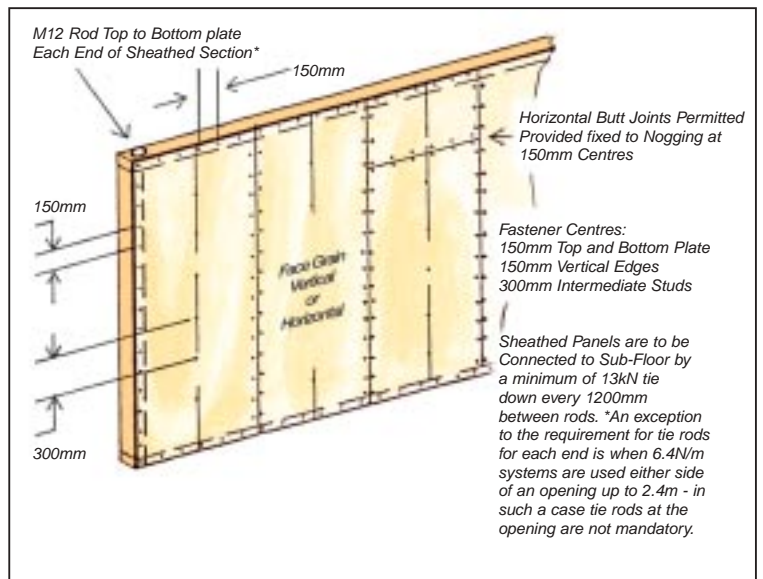

TABLE 9: Racking Resistance Reduction Factors

Width of Sheathed Section (m)	Reduction Factor
0.6	0.5
0.45	0.25
0.3	0.2
0.6 (with M10 coach screws at the panel corners)	1.0

NOTES:

- Reduction factors can be interpolated
- Reduction factors can only be applied to systems detailed in Tables 6, 7 and 8.
- A 600mm or wider section of the 6.4kN/m system detailed in Table 8 with the M12 rods fitted does not require the fitting of the M10 coach screws to achieve the reduction factor of 1.0.

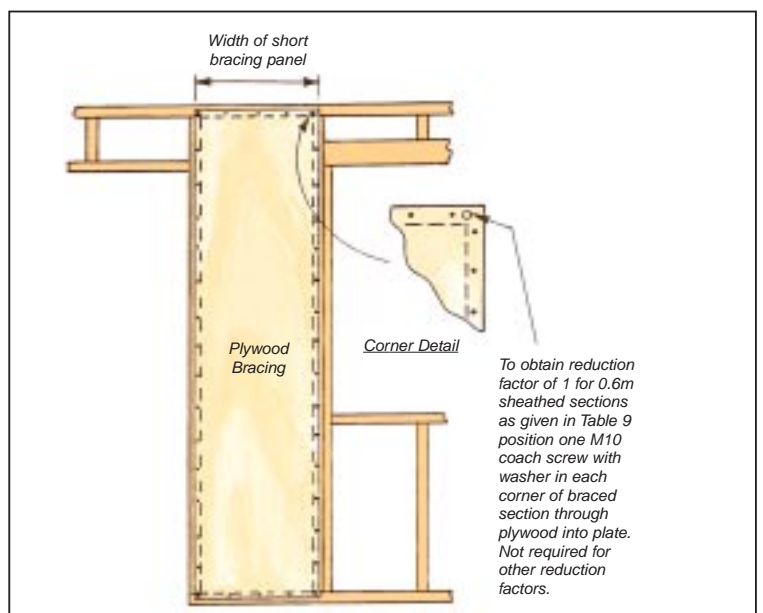
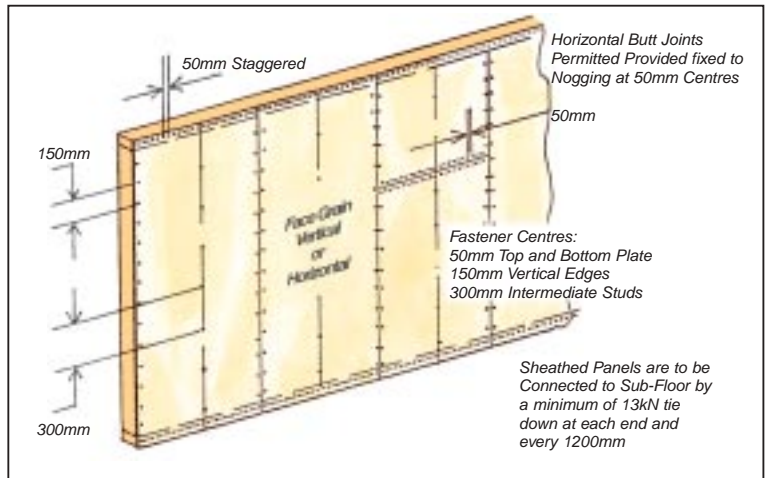

TABLE 10: Minimum Structural Plywood Thicknesses 6kN/m Bracing Capacity Systems (mm)

Plywood Stress Grade	Stud Spacing	
	450mm	600mm
F8	7	9
F11	6	7
F14	4	6
F27	4	4.5



NOTE: These systems are only applicable to sheathed sections a minimum of 900mm width

TABLE 11: Minimum Structural Plywood Thicknesses for 7.5kN/m Bracing Capacity Systems (mm)

Plywood Stress Grade	Stud Spacing	
	450mm	600mm
F11	4.5	4.5

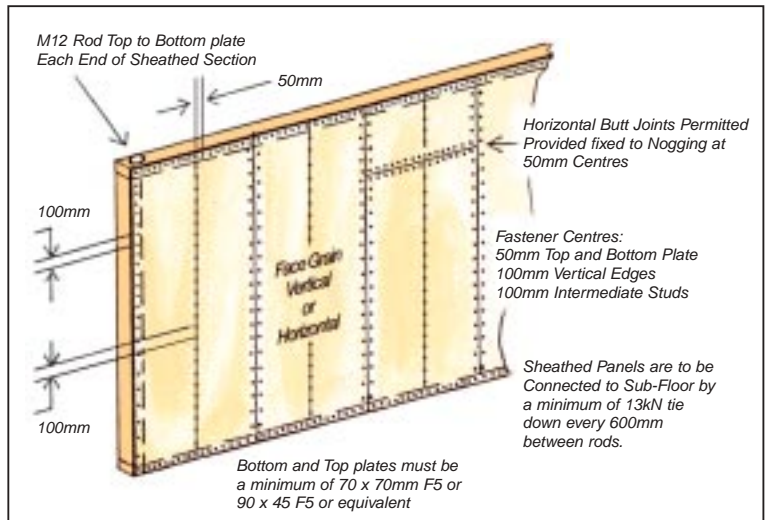

NOTE: These systems are only applicable to sheathed sections of a minimum of 900mm width

TABLE 12: Minimum Structural Plywood Thicknesses for 8.7kN/m Bracing Capacity Systems (mm)

Plywood Stress Grade	Stud Spacing	
	450mm	600mm
F11	7.0	7.0

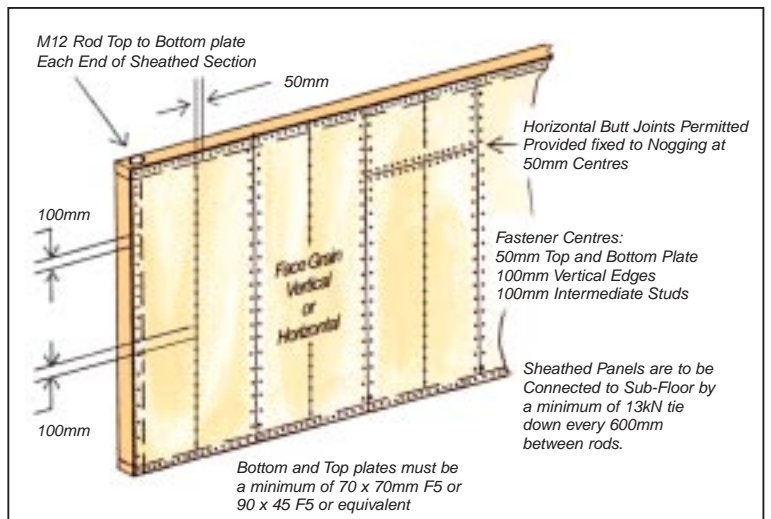

NOTE: These systems are only applicable to sheathed sections a minimum 900mm width

Internal Lining - Bullet Head Fasteners

Decorative structural plywood wall lining fixed with 2.5mm dia x 40mm bullet head nails can provide bracing resistance against wind loads. The nails may

be punched just below the plywood surface and the holes filled with a suitable putty. In grooved plywood lining the nails may be in the grooves.

Table 13: Minimum Structural Plywood Lining Thicknesses for 2.1kN/m Bracing Resistance (mm)

Plywood Stress Grade	Stud Spacing	
	450mm	600mm
F11	6	6

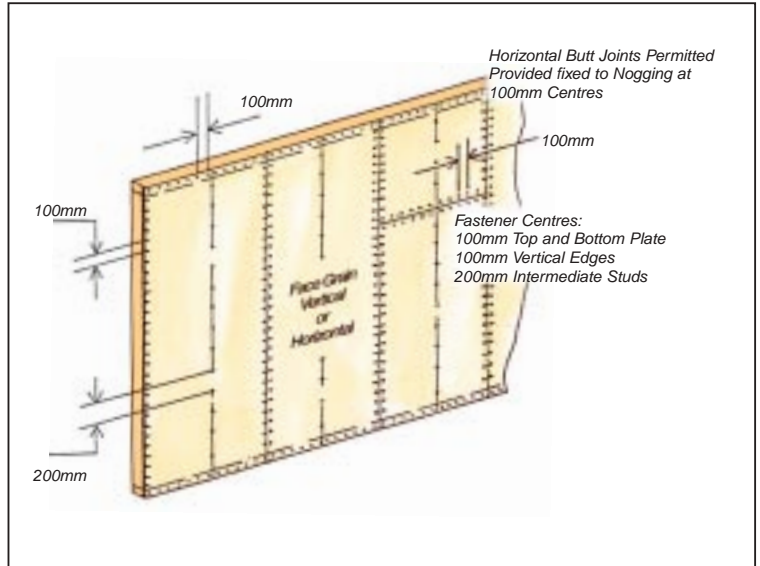

NOTE: This system is only applicable to sheathed sections a minimum of 900mm width

TABLE 14: Minimum Structural Plywood Glue/Nailed Lining for 5.3kN/m Bracing Resistance

Plywood Stress Grade	Stud Spacing	
	450mm	600mm
F11	6	6

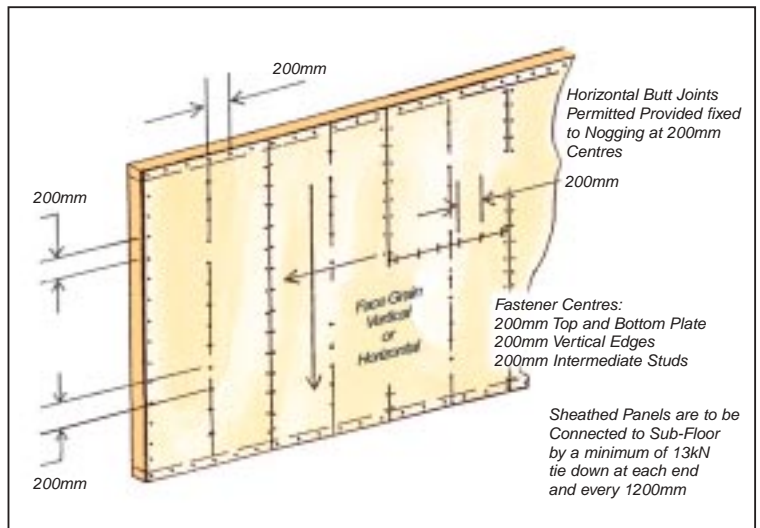

NOTES: 1. A continuous 6mm bead of an elastomeric adhesive to be applied to all nailed plywood joints to framing timbers, a double glue bead to be used where plywood sheets butt together on a stud or noggings.
2. This system is only applicable to sheathed sections a minimum of 900mm.

ADDITIONAL INSTALLATION REQUIREMENTS

To ensure the maximum effectiveness of structural plywood bracing the additional installation requirements detailed in this section are critical. The even distribution and maximum spacing of the bracing panels is vitally important to the structural performance of the structure. The tie down of the bottom plate against sideways forces, and the panels against overturning forces within the building framework, are crucial to the performance of the bracing. In addition, there must be sufficient structural connection between the ceiling/roof diaphragms and the top of the bracing walls to transfer the forces through the structure to the shear wall then down to the ground.

Distribution and Spacing of Bracing Walls

The bracing should be approximately evenly distributed throughout the building and provided in both primary directions. Where possible, bracing should be placed at the external corners of the building, with the balance evenly distributed in the external and internal walls. The object is to distribute the bracing in proportion to the areas of elevation, which, as these areas are proportional to the design racking forces, will result in the most effective structural solution for the building.

The other important criteria for distribution of the bracing is the maximum distance between bracing panels at right

General

All fasteners shall be a minimum of 7mm from the plywood edges. All plywood panel butt joints, either at vertical or horizontal edges, must be via connection of each panel to a common nogging or stud. Unattached panel edges or 'fly joints' are not permitted.

Each plywood bracing panel must be effectively fastened to the top and bottom plates and studs. In cases where secondary (ribbon) top plates are employed and the plywood bracing has been fixed to the lower top plate, the two plates must be connected together with fasteners of equivalent lateral shear capacity to the plywood to lower top plate fixings.

angles to the wind direction. Too large a distance will result in excessive forces being transferred to non-structural elements of the building. For wind classifications up to and including N2 this distance must not exceed 9000mm. For higher wind classifications the maximum spacing is to be in accordance with Table 15 for the relevant wind classification, ceiling depth and roof pitch. Where bracing cannot be placed in external walls because of openings and the like, a specifically designed structural plywood diaphragm floor, ceiling or roof can be used to transfer racking forces through to bracing walls that are designed to carry the loads.

DIAGRAM 3: Illustrates Distribution and Spacing of Bracing Walls

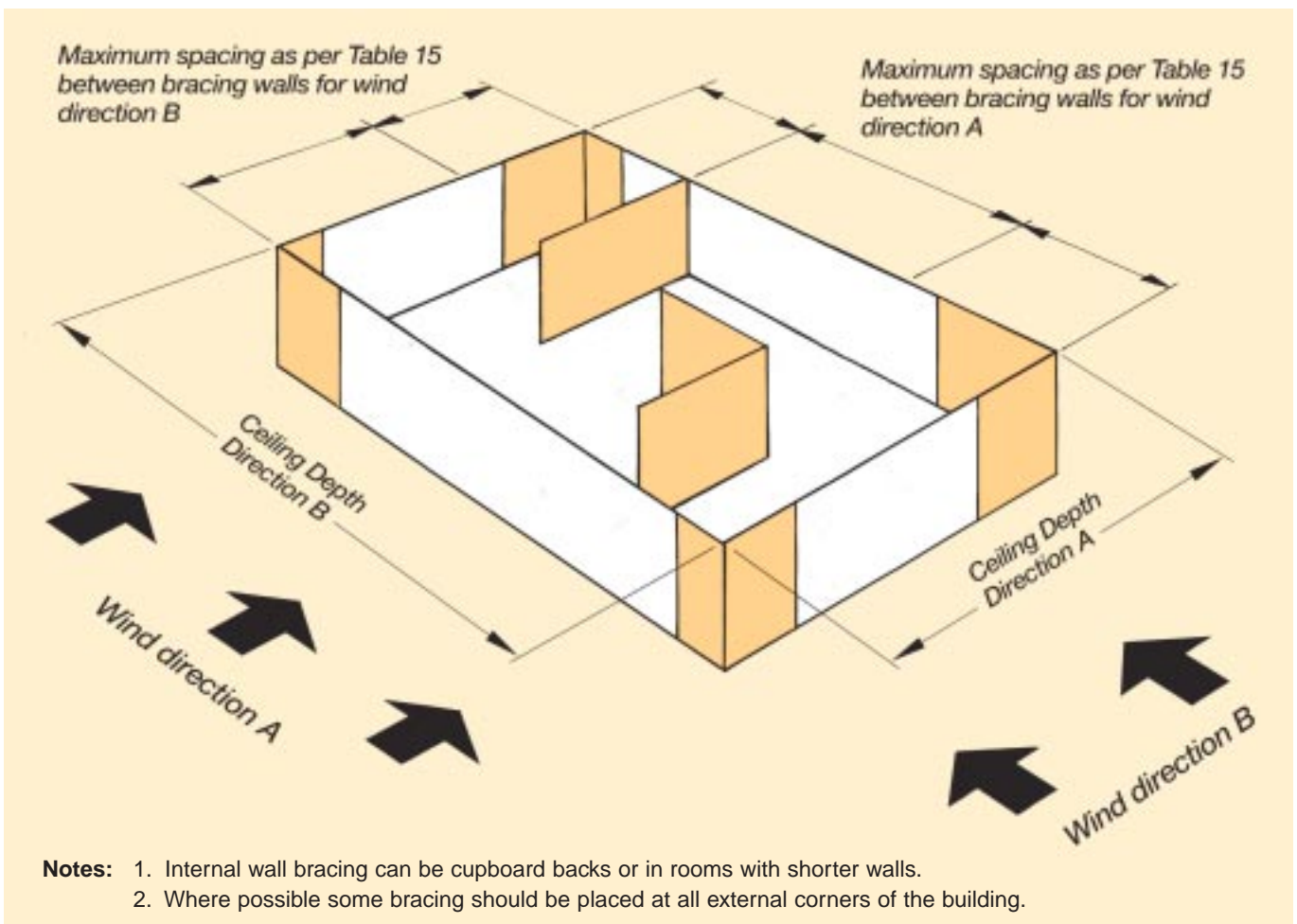

Distribution and Spacing of Bracing Walls (cont.)

TABLE 15: Maximum Spacing of Bracing Walls for-

(a) N1 and N2 Wind Classification-Maximum Bracing Wall Spacing - 9m

(b) N3 and C1 Wind classification

Ceiling Depth (m)	Maximum Bracing Wall Spacing (m)								
	Roof Pitch (Degrees)								
	0	5	10	15	17.5	20	25	30	35
≤4	5.9	6.6	7.4	7.5	7	6.4	5.1	4.4	4.2
5	7.4	8.3	9	9	8.6	7.9	6	5	4.7
6	8.9	9	9	9	9	8.8	6.7	5.6	5.1
7	9	9	9	9	9	9	7.1	6.1	5.5
8	9	9	9	9	9	9	7.6	6.7	5.7
9	9	9	9	9	9	9	7.9	7.2	5.9
10	9	9	9	9	9	9	8.4	7.9	6.2
11	9	9	9	9	9	9	8.7	7.9	6.4
12	9	9	9	9	9	9	9	7.9	6.6
13	9	9	9	9	9	9	9	8.1	6.6
14	9	9	9	9	9	9	9	8.3	6.7
15	9	9	9	9	9	9	9	8.4	6.8
16	9	9	9	9	9	9	9	8.6	6.9

(c) N4 and C2 Wind Classification

Ceiling Depth (m)	Maximum Bracing Wall Spacing (m)								
	Roof Pitch (Degrees)								
	0	5	10	15	17.5	20	25	30	35
≤4	3.9	4.3	4.9	5	4.6	4.2	3.4	2.9	2.8
5	4.9	5.4	6.1	6.2	5.7	5.2	4	3.3	3.1
6	5.9	6.6	7.3	7.4	6.5	5.8	4.4	3.7	3.4
7	6.9	7.9	8.6	8.3	7.2	6.3	4.7	4	3.7
8	7.9	9	9	9	7.7	6.7	5	4.4	3.8
9	8.8	9	9	9	8.4	7.1	5.2	4.8	3.9
10	9	9	9	9	8.9	7.4	5.5	5.2	4.1
11	9	9	9	9	9	7.7	5.8	5.2	4.1
12	9	9	9	9	9	7.9	5.9	5.2	4.3
13	9	9	9	9	9	8.1	6.1	5.3	4.3
14	9	9	9	9	9	8.2	6.1	5.5	4.4
15	9	9	9	9	9	8.5	6.3	5.5	4.5
16	9	9	9	9	9	8.6	6.5	5.7	4.6

(d) C3 Wind Classification

Ceiling Depth (m)	Maximum Bracing Wall Spacing (m)								
	Roof Pitch (Degrees)								
	0	5	10	15	17.5	20	25	30	35
≤4	2.7	3	3.4	3.5	3.2	3	2.3	2	1.9
5	3.4	3.8	4.3	4.4	4	3.6	2.8	2.3	2.2
6	4.1	4.6	5.1	5.1	4.6	4.1	3.1	2.6	2.4
7	4.8	5.5	6	5.8	5	4.4	3.3	2.8	2.6
8	5.5	6.3	6.7	6.5	5.4	4.7	3.5	3.1	2.6
9	6.2	7.1	7.6	7.2	5.9	5	3.7	3.3	2.7
10	6.8	7.9	8.3	7.8	6.2	5.1	3.9	3.6	2.9
11	7.5	8.7	9	8.4	6.5	5.3	4	3.6	2.9
12	8.2	9	9	8.6	6.7	5.5	4.1	3.7	3
13	8.9	9	9	8.9	6.9	5.7	4.3	3.7	3
14	9	9	9	9	7.1	5.7	4.3	3.8	3.1
15	9	9	9	9	7.2	5.9	4.4	3.9	3.1
16	9	9	9	9	7.4	6	4.6	4	3.2

- NOTES:**
1. For wind classifications refer to Table 2.
 2. Where a structural plywood diaphragm ceiling is used the maximum spacings may be increased by multiplying the spacing in the Table by 1.5 provided the bracing wall spacing does not exceed 9m.

Fixing of Bottom of Bracing Walls

The horizontal forces due to wind and earthquakes being resisted by bracing walls results in two separate types of action on the bracing panels. The first action is a sideways sliding force pushing on the bottom plate. Sufficient fixings of the bottom plate to the sub-floor can be designed to resist this sideways 'shear' force.

The second action is due to rotation or overturning and is best resisted by tie rods from the top plate to the sub-floor and located at each end of the bracing wall. For the lower capacity bracing walls connection of the bottom plate to the sub-floor can overcome these overturning moments.

Bottom Plate Fixing for up to 3.4kN/m Systems

No additional bottom plate fixing is required for these lower capacity bracing systems. Obviously, nominal bottom plate fixing as specified in AS1684 is still required. However, if the 3.4kN/m system is used on

both sides of a frame to double the bracing capacity in that section of wall, then the bottom plate fixing will need to be upgraded to be equivalent for a 6.4kN/m system. Table 16 details nominal bottom plate fixings.

TABLE 16: Nominal Bottom Plate Fixing for up to 3.4kN/m Bracing

Wind Classification	Concrete Slab Sub-Floor	Hardwood or Cypress Sub-Floor	Softwood or Low Density Timber Sub-Floor
N1, N2, N3 and C1	75mm masonry nails, screws or bolts at 1200mm maximum spacing	2 only 3.15mm nails at 600mm maximum spacing 75mm long nails for up to 38mm thick plates or 90mm long nails for plates 38 to 50mm thick.	2 only 3.75mm nails at 600mm maximum spacing 75mm long nails for up to 38mm thick plates or 90mm long nails for plates 38 to 50mm thick.
C2	75mm masonry nails, screws or bolts at 900mm maximum spacing	Not applicable	Not applicable
C3	75mm masonry nails, screws or bolts at 600mm maximum spacing	Not applicable	Not applicable

Bottom Plate Fixing for 5.3, 6.0 and 6.4kN/m Systems

The minimum fixing requirement for 5.3, 6.0 and 6.4kN/m bracing capacity systems is 13kN tie down every 1200mm or equivalent. A looped 30mm x 0.8mm

width galvanised looped strap as shown in Diagram 4 is equivalent to 13kN tie down.

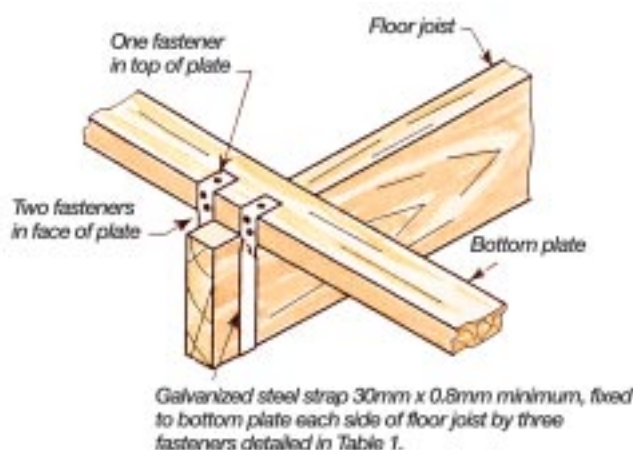

DIAGRAM 4: Looped Strap Bottom Plate Fixing

The tie down capacity of some bolts through a range of timber joint strengths are presented in Table 17. If the bolts are used in concrete slabs they must be

appropriately embedded. For lower capacity bolt joints the resistance can be accomplished by reducing the spacing of the bolts.

TABLE 17: Tie Down Capacity of Bolts through Timber (kN)

Bolt Classification	J2	J3	J4	JD4	JD5	JD6
M10	18	18	18	15	12	9
M12	27	27	26	20	16	12
M16	50	50	46	35	28	21

Bottom Plate Fixing for 7.5 and 8.7kN/m Systems

The minimum fixing requirement as used in the actual testing of 7.5 and 8.7kN/m bracing capacity systems is 13kN

tie down every 600mm or equivalent. Reference to the tie down capacities shown in Table 17 provides some guidance.

Uplift Resistance of Structural Plywood Sheathed Walls

Plywood sheathed wall frames can provide roof hold-down by transferring the wind uplift loads through the rafter or trusses to the top plate, then from the top plate to the bottom plate through the plywood acting in tension. The loads are then transferred to the sub-floor or floor by the appropriate connection of the bottom plate to floor joists or concrete slab. The bottom plate to sub-floor fixing must be

at least 13kN tie down every 1200mm or equivalent to meet the required uplift. Connection of the plates to the plywood is critical. When installed as specified in Table 18, the plywood sheathed wall sections act as a continuous cyclone rod thereby avoiding stress concentrations. The uplift resistances given in Table 18 were based on prototyping testing full panels.

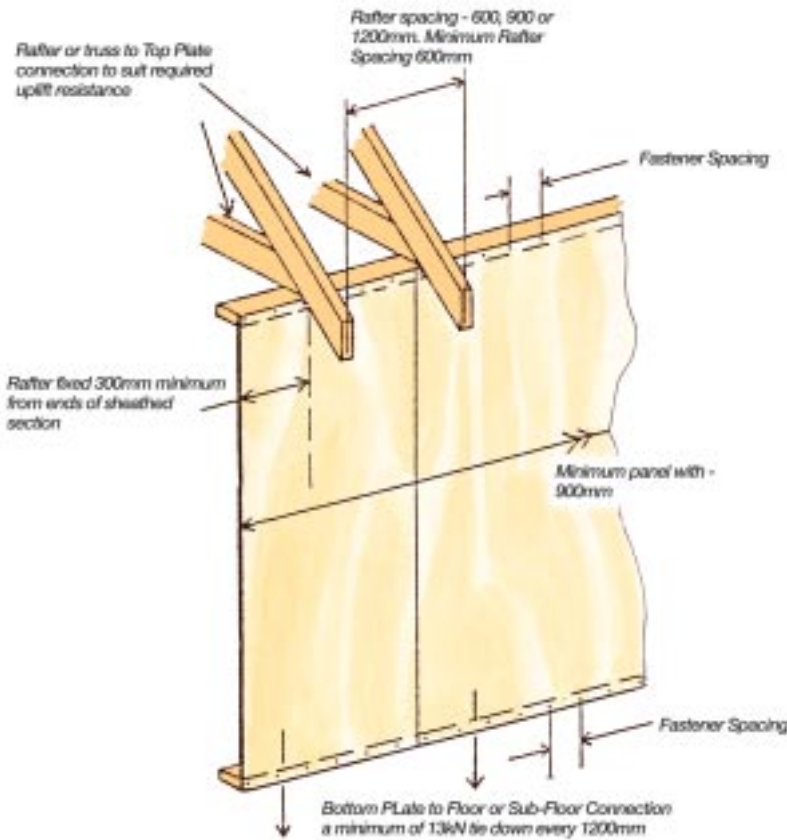

DIAGRAM 5: Uplift Resistance of Plywood Sheathed Wall Frames

Table 18 gives the allowable uplift resistance in kN per rafter for two plywood to top and bottom plate connection methods. The fastener specification is as detailed in Table 1 and the uplift resistances apply to all the plywood thicknesses and

stress grades given in Tables 5 to 12. A single 900mm bracing panel can provide the specified uplift resistance for a rafter if the rafter is fixed a minimum of 300mm from either end of the plywood panel as shown in Diagram 5.

TABLE 18: Allowable Uplift Resistance of Plywood Sheathed Wall Systems

Allowable Uplift Resistance (kN/Rafter)	Fastener Spacing (mm)	
	Hand or Power Driven Nails	Staples
16.7	50	33
10.4	150	100

The design of the rafter or truss to top plate connection is critical. The connection design can be as per AS1684. Alternatively, the connection shown in Diagram 6 is acceptable for both uplift resistances given in Table 18.

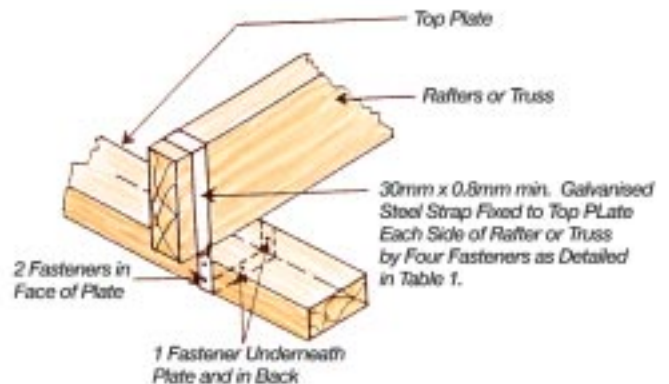

DIAGRAM 6 : Connection of Top Plate to Rafter or Truss

Fixing of top of bracing walls

If the horizontal forces due to wind or earthquakes in the ceiling/top floor/roof diaphragm are to be

transferred into the wall bracing there must be sufficient structural connection between the two.

Internal Bracing Walls

All internal bracing walls have to be fixed to the ceiling or roof frame and/or to the external wall frame with structural connections of equivalent shear capacity to

the bracing capacity of the particular bracing wall. AS1684 provides a range of suitable connections.

External Bracing Walls Under Ends of Eaves

If external walls under ends of eaves are used as bracing walls they have to be structurally connected to the main ceiling diaphragm. This can be achieved by fixing structural plywood bracing to the rafter overhangs

and connecting the panel to the top of the bracing wall and to the ceiling diaphragm with equivalent nailing to the wall bracing.

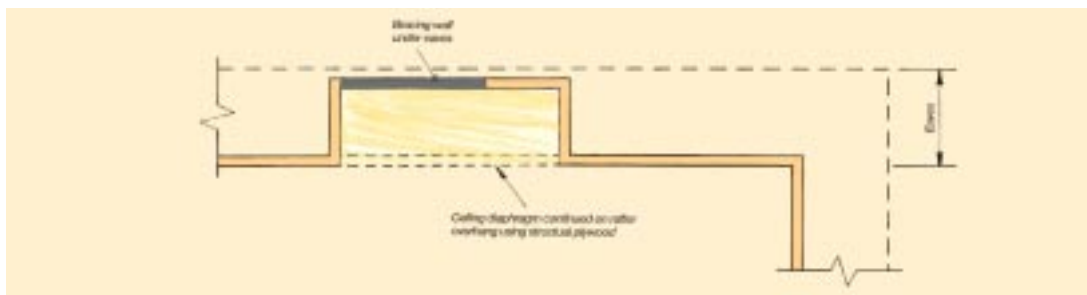

DIAGRAM 7: Plan View External Bracing Under Ends of Eaves

HOLES THROUGH PLYWOOD BRACING

During construction, for various reasons, tradespeople often wish to make penetrations through structural plywood bracing panels. A neat hole (i.e. not overcut) of up to 100mm x 100mm within an envelope of 100mm from the vertical and top edges and 200mm of the bottom edge of the bracing panel will have no significant effect on the bracing capacity. Multiple 100mm x 100mm holes are allowable within the

envelope but their centres must be no closer than 600mm.

One hole of up to 400mm x 400mm located between the studs and within the envelope defined above, with nogging framing the hole and fixing of the plywood to the framing as per the requirements for the top and bottom plate is acceptable.

DESIGN EXAMPLE

Determine the bracing requirements for a 15m x 9m double storey gable roofed dwelling with 20° roof pitch and 2.7m ceiling heights as shown in Diagram 8.

Assume the Local Authority has advised the Wind Classification for the site to be N2.

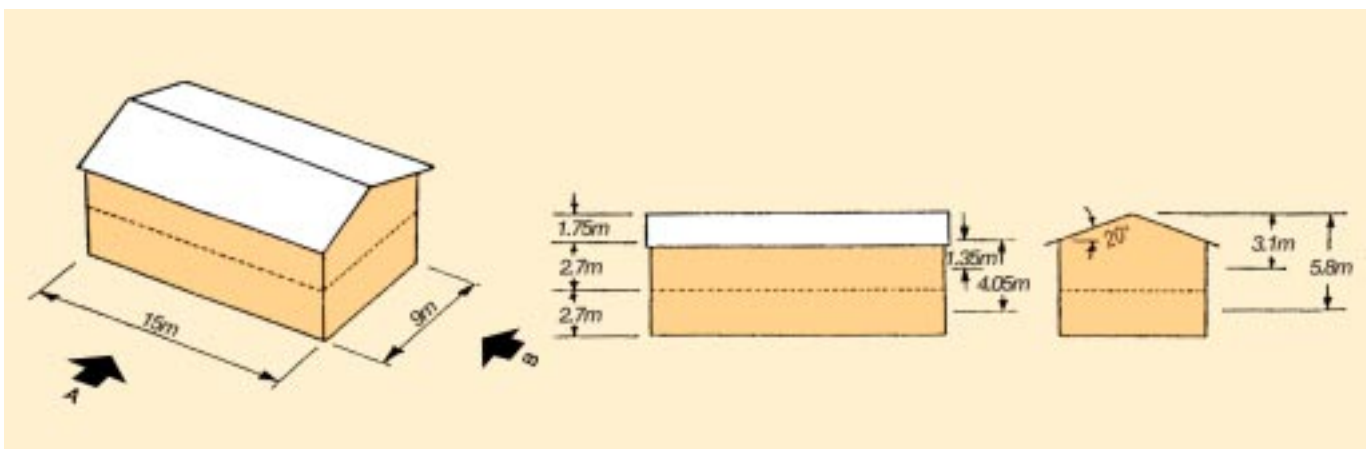

DIAGRAM 8 : Building Dimensions for Design Example

Firstly, the wind forces to be resisted by the building frames in both primary directions and for both storeys need to be established. As the Wind Classification has

been given, the next step is to calculate the Areas of Elevation using the dimensions from Diagram 8 as detailed in Table 19.

DESIGN EXAMPLE (cont.)

TABLE 19: Areas of Elevation for Design Example

Storey	Wind Direction	Calculation	Area of Elevation (m ²)
Upper	A	15m x 3.1m	46.5
	B	9m x 1.35m + 9m x 1.75m/2	20
Lower	A	15m x 5.8m	87
	B	9m x 4.05m + 9m x 1.75m/2	44.3

The second step, as detailed in Table 20, is to calculate the Design Racking Forces for each primary direction

and storey using the Area of Elevation and the relevant Wind Pressure from Table 4.

TABLE 20: Design Racking Forces for Design Example

Storey	Wind Direction	Area of Elevation (m ²)	Wind Pressure (kPa)	Calculation	Design Racking Force (kN)
Upper	A	46.5	0.61 - Table 4 (b)	46.5 x 0.61	28.4
	B	20	0.92 - Table 4 (a)	20 x 0.92	18.4
Lower	A	87	0.72 - Table 4 (c)	87 x 0.72	62.6
	B	44.3	0.92 - Table 4 (a)	44.3 x 0.92	40.8

NOTE: For other Wind Classifications the Design Racking Force can now be reduced or increased using the multiplier given in Table 3.

structural bracing spacing requirements. If it is decided the rodded systems (Tables 10 to 12) will not be specified then the 6kN/m close nailed system will be the one with the largest capacity.

The final step is to select the appropriate bracing systems and calculate the minimum number of structural plywood bracing panels required. In selecting the bracing systems it is good practice to use lower capacity systems in top storey or single storey frames and higher capacity systems in the lower storey frames. This practice lends itself to having bracing placed in all the building corners and meeting the maximum

For this design example we will nominate 3.4kN/m systems on the top floor and 6kN/m on the lower floor. Additionally, we will assume the stud spacing to be 450mm, thus 900mm wide structural plywood panels would be the most practical panel width. Table 21 shows how to calculate the minimum bracing requirement.

TABLE 21: Calculation of Number of Bracing Panels Required

Storey	Wind Direction	Calculation (Force/Capacity)	Bracing Required (m)	Number of 900mm Panels Required
Upper	A	28.4/3.4	8.4	8.4/0.9 = 9.3 i.e. 10 @ 3.4kN/m
	B	18.4/3.4	5.4	5.4/0.9 = 6 i.e. 6 @ 3.4kN/m
Lower	A	62.6/6	10.4	10.4/0.9 = 11.6 i.e. 12 @ 6kN/m
	B	40.8/6	6.8	6.8/0.9 = 7.6 i.e. 8 @ 6kN/m

Table 21 provides one option for minimum AS1684 bracing requirements, and all that remains now is to evenly distribute the panels throughout the framing. To brace the frames in both storeys for wind direction B, installation of the plywood in the front and back 15m walls of both storeys, preferably at each corner, would meet the Code requirements as these walls are 9m apart - the maximum allowed in Table 15 for Wind Classifications N1 and N2. The bracing of the framing

for wind direction A will require some of the bracing to be installed in internal walls, as the relevant external walls are spaced at 15m. These panels can be located in the backs of built-in cupboards, or on the walls of smaller rooms, e.g. toilets. Decorative structural plywood wall panelling is another alternative. It must be remembered these internal bracing walls have to be structurally connected to the ceiling/roof framing to be effective as bracing.

APPENDIX

Permissible Stress Design Capacities

For reference, Table 22 lists the appropriate permissible stress capacities for the structural plywood bracing systems detailed in this brochure.

TABLE 22: Permissible Stress Bracing Capacities Design

Table Number	Ultimate Limit State Capacity	Permissible Stress Design Capacity
5	3kN/m	2kN/m
6	3.4kN/m	2.25kN/m
8	3.4kN/m	2.25kN/m
9	6kN/m	4kN/m
10	6.4kN/m	4kN/m
11	7.5kN/m	5kN/m
12	8.7kN/m	6.5kN/m
13	2.1kN/m	1.5kN/m
14	5.3kN/m	3.5kN/m

PRODUCT CERTIFIED



JAS-ANZ



ADDITIONAL PAA LITERATURE



The following technical manuals and publications are available from Plywood Association of Australia.

- Plywood Webbed Structural Beams for Domestic Housing - 50 pages
- Featuring Plywood in Buildings - 16 pages
- T&G Structural Plywood for Residential Flooring - 8 pages
- LP91 Low Profile Stressed Skin Plywood Floor System - 8 pages
- Timber Tops for Concrete Slabs - 8 pages
- Structural Plywood for Commercial and Industrial Flooring - Design Manual - 12 pages
- Plywood in Concrete Formwork - 56 pages
- Plywood Association of Australia Ltd. - Role and Activities - 8 pages
- Plywood Association of Australia Ltd. - Quality Control and Product Certification - 2 pages
- Design Guide for Plywood Webbed Beams - 16 pages
- New Joint Australian & New Zealand Standard for Structural Plywood - 4 pages
- Plywood - the Only Engineered Wood Panel - 4 pages
- Facts About Plywood - 42 pages

PLYWOOD ASSOCIATION OF AUSTRALIA LTD.,

PLYWOOD ASSOCIATION OF AUSTRALIA LTD.

(A.C.N. 009 704 901)

'PLYWOOD HOUSE', 3 DUNLOP STREET, NEWSTEAD, QUEENSLAND, AUSTRALIA
P.O. Box 2108, Fortitude Valley, M.A.C. Qld. 4006. Phone (07) 3854 1228 ● Fax (07) 3252 4769
email: folk@plywoodassn.com.au



An accredited body listed under Registration Number S1220792AS
QUALITY SYSTEM CERTIFIED TO AS/NZS/ISO9002